

MX82

8 CHANNEL STEREO MIC/LINE MIXER INSTALLATION AND OPERATION MANUAL

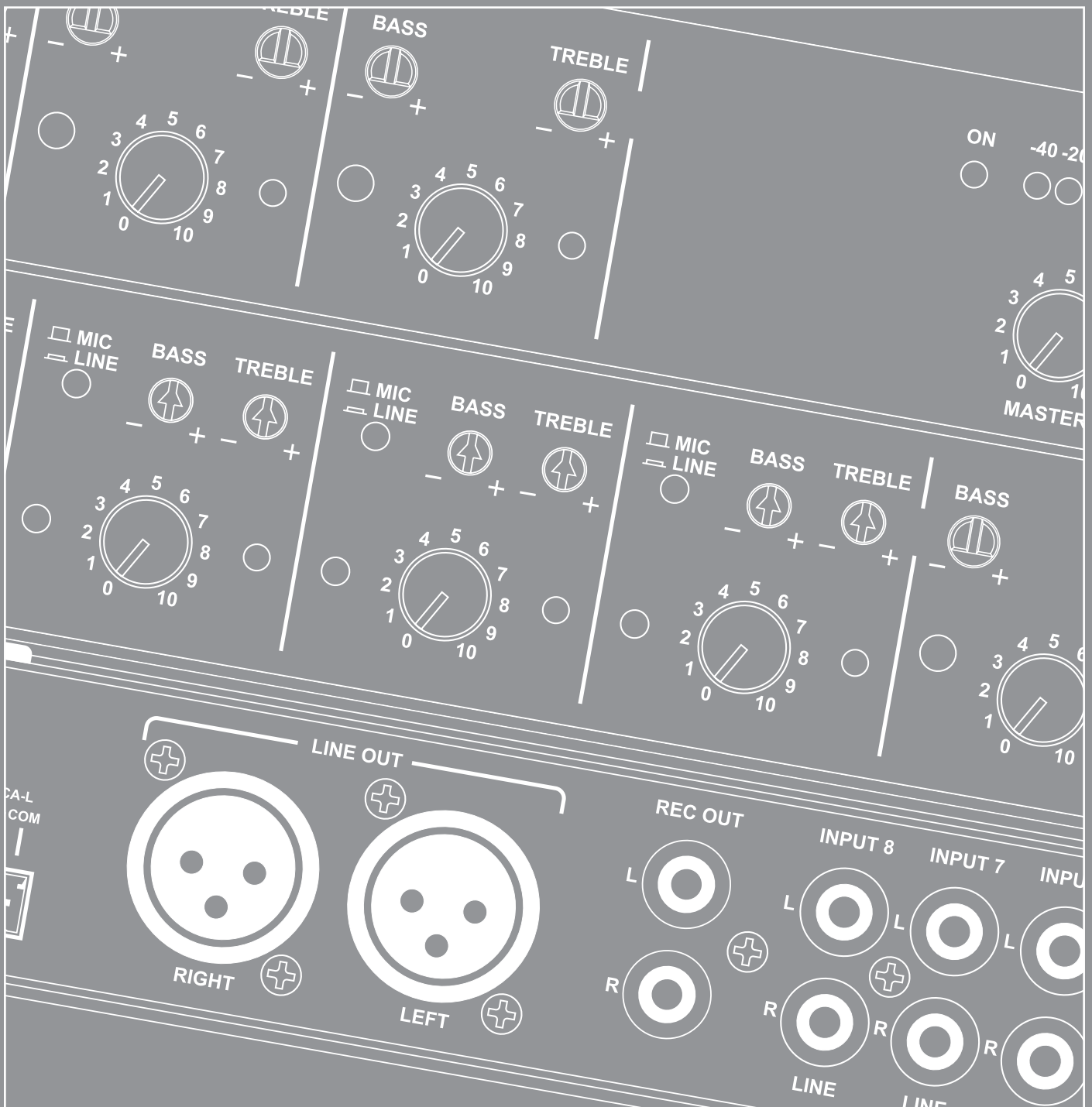



IMPORTANT SAFETY INFORMATION



1. Save the carton and packing material even if the equipment has arrived in good condition. Should you ever need to ship the unit, use only the original factory packing.
2. Read all documentation before operating your equipment. Retain all documentation for future reference.
3. Follow all instructions printed on unit chassis for proper operation.
4. Do not spill water or other liquids into or on the unit, or operate the unit while standing in liquid.
5. Make sure power outlets conform to the power requirements listed on the back of the unit.
6. Do not use the unit if the electrical power cord is frayed or broken. The power supply cords should be routed so that they are not likely to be walked on or pinched by items placed upon or against them, paying particular attention to cords and plugs, convenience receptacles, and the point where they exit from the appliance.
7. Always operate the unit with the AC ground wire connected to the electrical system ground. Precautions should be taken so that the means of grounding of a piece of equipment is not defeated.
8. Mains voltage must be correct and the same as that printed on the rear of the unit. Damage caused by connection to improper AC voltage is not covered by any warranty.
9. Have gain controls on amplifiers turned down during power-up to prevent speaker damage if there are high signal levels at the inputs.
10. Power down & disconnect units from mains voltage before making connections.
11. Never hold a power switch in the "ON" position if it won't stay there itself!
12. Do not use the unit near stoves, heat registers, radiators, or other heat producing devices.
13. Do not block fan intake or exhaust ports. Do not operate equipment on a surface or in an environment which may impede the normal flow of air around the unit, such as a bed, rug, weathersheet, carpet, or completely enclosed rack. If the unit is used in an extremely dusty or smoky environment, the unit should be periodically "blown free" of foreign matter.
14. Do not remove the cover. Removing the cover will expose you to potentially dangerous voltages. There are no user serviceable parts inside.
15. Do not drive the inputs with a signal level greater than that required to drive equipment to full output.
16. Do not connect the inputs / outputs of amplifiers or consoles to any other voltage source, such as a battery, mains source, or power supply, regardless of whether the amplifier or console is turned on or off.
17. Do not run the output of any amplifier channel back into another channel's input. Do not parallel- or series-connect an amplifier output with any other amplifier output. Australian Monitor Inc is not responsible for damage to loudspeakers for any reason.
18. Do not ground any red ("hot") terminal. Never connect a "hot" (red) output to ground or to another "hot" (red) output!
19. Non-use periods. The power cord of equipment should be unplugged from the outlet when left unused for a long period of time.
20. Service Information Equipment should be serviced by qualified service personnel when:
 - A. The power supply cord or the plug has been damaged.
 - B. Objects have fallen, or liquid has been spilled into the equipment
 - C. The equipment has been exposed to rain
 - D. The equipment does not appear to operate normally, or exhibits a marked change in performance
 - E. The equipment has been dropped, or the enclosure damaged.

THIS SAFETY INFORMATION IS OF A GENERAL NATURE AND MAY BE SUPERSEDED BY INSTRUCTIONS CONTAINED WITHIN THIS MANUAL

INTRODUCTION AND CONTENTS





The MX82 is an 8 channel stereo audio mixer that operates from 110/230-240 VAC @ 50/60 Hz. The MX82 offers high quality audio performance & a wide array of features in a standard 1 RU size. For table mounting, rubber feet are supplied but these can be removed if rack mounting is intended. There are four mic/line inputs consisting of balanced XLR inputs switchable between mic & line level. The first 4 channels also feature a line level direct output which can be used to feed additional amplifiers, mixers or recording devices. An internal jumper allows the first 4 inputs to be routed to the direct output and the master outputs or just the direct output, either pre or post fader. Inputs 5-8 are four dedicated stereo RCA line level inputs.

Each input has front panel trim control, status LED and bass & treble controls. Priority muting is available as an optional addition as is remote VCA master control and tone generation.

The MX82 also features 4 segment LED output metering & the ability to internally switch input 1 to be either pre or post master. With both Headphone out & Record out also available the MX82 is extremely versatile. The MX82 has taken the AMIS heritage of contractor friendly installation product & has added the audio fidelity needed in today's AV contracting market.

INTRODUCTION	3
FRONT PANEL	4
REAR PANEL	5
INTERNAL ADJUSTMENTS	6
INSTALLATION & TROUBLESHOOTING	7
BASIC SETUP AND OPERATION	8
DIMENSIONS	9
BLOCK DIAGRAM	10
SPECIFICATIONS	11

AUS, EUR, USA
Copyright 9th Feb 2006
Rev A 13/02/07

	CAUTION RISK OF ELECTRIC SHOCK DO NOT OPEN	
<p>CAUTION: TO REDUCE THE RISK OF ELECTRIC SHOCK, DO NOT REMOVE COVER (OR BACK), NO USER SERVICEABLE PARTS INSIDE, REFER SERVICING TO QUALIFIED SERVICE PERSONAL.</p>		
WARNING! TO REDUCE THE RISK OF FIRE OR ELECTRIC SHOCK DO NOT EXPOSE THIS EQUIPMENT TO RAIN OR MOISTURE.		
		This symbol is intended to alert the user to the presence of uninsulated "dangerous voltage" within the products enclosure that may be of sufficient magnitude to constitute a risk of electric shock to persons.
		This symbol is intended to alert the user to the presence of important operational and maintenance (servicing) instructions in the literature accompanying the appliance.
Caution:		To prevent electric shock do not use this (polarised) plug with an extension cord, receptacle or other outlet unless the blades can be fully inserted to prevent blade exposure. To prevent electric shock, match wide blade of plug to wide slot, fully insert.

FRONT PANEL

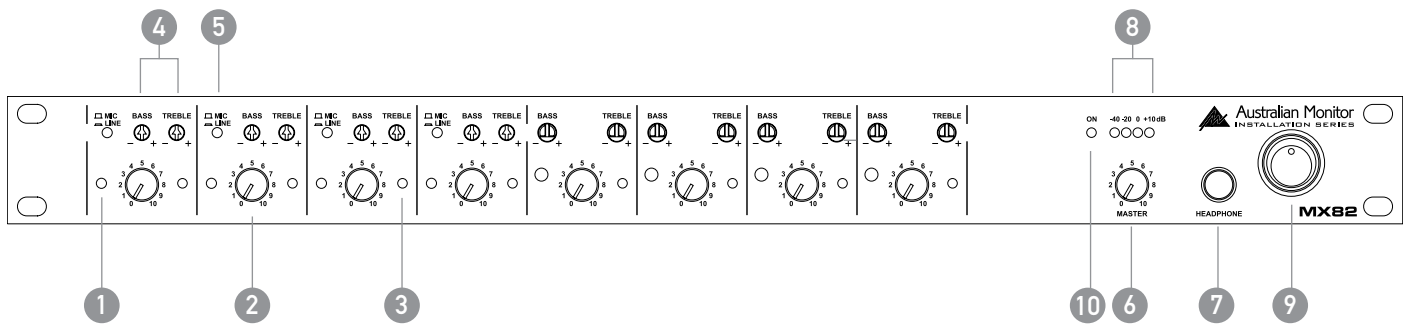

1 GAIN TRIM

This control is used to adjust the input gain and affects both the XLR and the RCA inputs. The input gain can be adjusted by +/- 15dB. This allows a wide range of program sources to be set up with optimum gain structure. With the gain trim in the centre position, the boost/cut is set to 0dB. See the block diagram on page 10 for details of the gain structure.

2 LEVEL

Controls the level of the input signal.

3 INPUT STATUS LEDS

Each input has an LED status indicator. The LED is green when there is signal present and red if the signal is approaching clip. If the LED begins to light red this would indicate the internal signal level is 6dB before clip. Note that the front panel level control is post status LED and as such, the status LED is NOT affected by the level control. If an input channel is clipping use the gain trim to adjust the correct amount of input level.

4 CHANNEL TONE CONTROLS

Each input has a 2 band EQ.
Bass – +/-12dB 100Hz shelving
Treble – +/-9dB 10kHz shelving

5 MIC / LINE

Channels 1 to 4 have a switch which controls the sensitivity of the XLR input. In the off/out or "MIC" position the XLR input is suitable for use with microphones; in the on/in or "LINE" position the XLR input is suitable for use with a balanced line level signal.

 NOTE: The Mic/Line switches only affect the XLR input.

6 MASTER

This pot controls the overall mixed output level for both left and right channels.

7 HEADPHONE

This 1/4" jack socket allows headphones to be used for monitoring. It can be set as pre or post master volume control. See "Internal Settings" on page 6. Default factory setting is pre master volume control.

8 MASTER VU DISPLAY

This VU display indicates output level for both left and right channels.

9 POWER SWITCH

This switch switches power from the mains. The up position is on.

10 POWER ON LED

This indicates there is power to the unit.

REAR PANEL

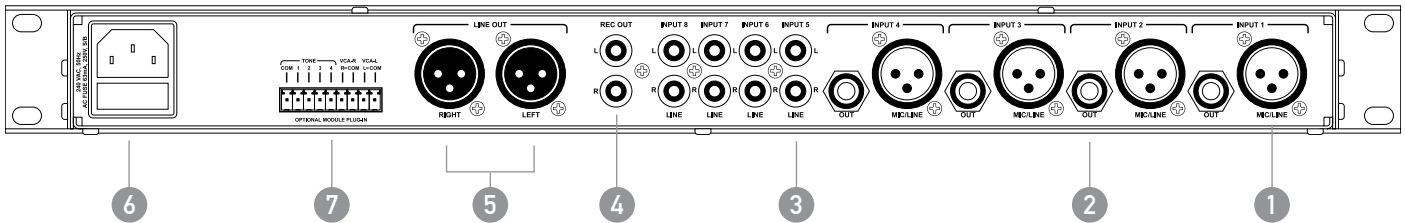

1 CHANNEL INPUTS

Channels 1 to 4 are mic/line switchable XLR balanced inputs. It accepts mic or line level signals depending on the gain switch position. The XLR will also have +15V phantom power if selected on the switch accessed through the lid, see Internal Adjustments.

2 DIRECT OUT

A unique feature of the MX82 is the individual direct output available for each of the first 4 channels. The direct outputs are accessed via balanced TRS 1/4" sockets for each channel. The level of each output is 0dBu (nominal). The signal from any of the four channels can be disconnected from the main left/right outputs, see Internal Adjustments. The direct outputs are adjustable to be pre or post the channel level control, see the Internal Adjustments.

3 STEREO CHANNEL INPUTS

Channels 5 to 8 are stereo line level RCA unbalanced inputs.

4 REC OUT

The REC OUT output is on unbalanced RCA connectors. The output is not affected by the MASTER volume control.

5 LEFT AND RIGHT OUTPUT

The OUTPUT XLR's provide balanced line level signal of the left and right bus respectively.

 **NOTE:** When wiring the LINE output as unbalanced, Pin2 should be wired as hot and Pin1 should be wired as ground/shield. Do not wire Pin3.

6 IEC MAINS INPUT SOCKET

This is a standard IEC 3 pin socket. It accepts a standard IEC mains cable, provided. The fuse draw contains the mains fuse and a spare. The mains fuse is a time lag (slow blow) HRC 20mm x 5mm ceramic type fuse.

The ratings are:

230V/240V model:	63mA
115V model:	120mA

 **IMPORTANT:** Always replace the fuse with one of the same value and type.

 **NOTE:** Always disconnect power to the amplifier before replacing fuses.

7 OPTIONAL MODULE INPUTS

This socket is used with a tone module and/or VCA module.

INTERNAL ADJUSTMENTS

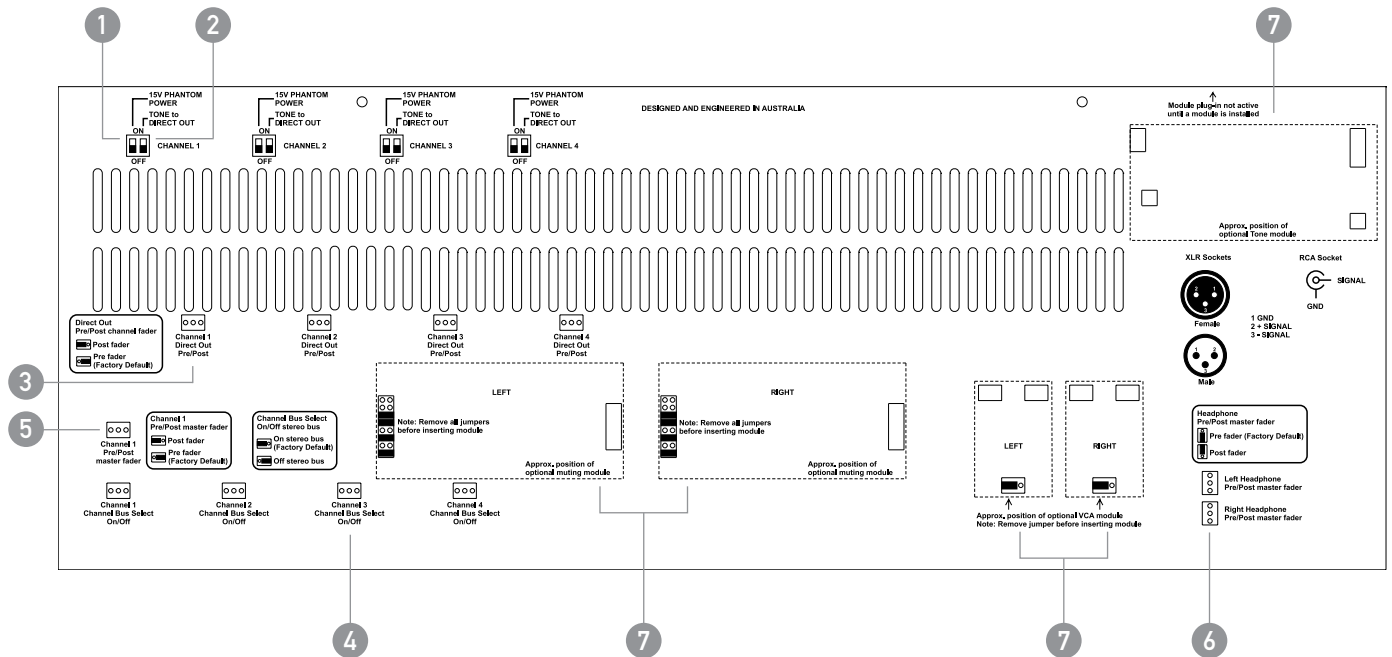

1 P/P – PHANTOM POWER

15V phantom power is available for condenser or electret microphones on the XLR input when this switch is in the “ON” position. This switch is accessible through the lid of the MX82.

2 TONE TO DIRECT OUT

Signal from the optional tone generator can be removed from each direct output via this switch. When in the ON position, the tones (when activated from the optional tone module) are fed to the corresponding direct output as well as the master Left/Right outputs. When the switch is set to the OFF position, the tones are only present at the Master Left/Right outputs. This switch is accessible through the lid of the MX82.

3 CHANNEL DIRECT OUT PRE/POST FADER

The pre or post assignment of the direct output is set via this jumper. This is used to make the Direct Outputs either pre or post channel fader volume. Set to the Channel 1 side the Direct Output is post fader (i.e. the channel fader volume affects the Direct Output). Set to the Channel 8 side the Direct Output is pre fader. The default factory setting is pre fader.

4 CHANNEL BUS SELECT ON/OFF MASTER OUTPUT

This jumper is provided for each of the first 4 channels. The jumpers are located near the front of the unit. When in the ON position (channel 1 side), signal from that channel is fed to both the master outputs and the direct outputs. When the switch is in the OFF position (channel 8 side), signal from that channel is fed to the direct line level output only.

5 CHANNEL 1 ROUTING

If channel 1 is being used as a priority input it can be routed so that the master volume does not affect channel 1. The default factory setting is pre master fader meaning the master volume affects channel 1 in the mix. The jumper header is located above channel 1 pot. Move the jumper to link the two pins nearer channel 8 to set channel 1 to post master fader.

6 HEADPHONE ROUTING

The headphone level can be routed so that it is affected by the master volume. The default factory setting is pre master fader meaning the master volume does not affect the headphone volume. The jumper header is located just behind the front panel near the master pot. Move the jumper to link the two pins nearer the inputs to set the headphone to post master fader. Remember to set both the left and right channels.

7 OPTIONAL MODULES

The MX82 can have installed:

- 2 VCA modules for left and right outputs
- Tone Generator module
- 2 Priority Muting modules for left and right outputs

See your local Australian Monitor dealer for more information.

INSTALLATION AND TROUBLESHOOTING

INPUT CONNECTIONS

For wiring balanced in, pin 2 is hot. Unbalanced wiring on the microphone inputs is not recommended. Balanced input wiring (shielded pair cable) is recommended.

Unbalanced RCA wiring should be kept as short as possible. Typically less than 3m.

LINE OUTPUT

The LINE output XLR can be used to connect up to 6 booster amplifiers. Balanced wiring (shielded pair cable) is recommended.

NOTE: When wiring the LINE output as unbalanced, Pin2 should be wired as hot and Pin1 should be wired as ground/shield. Do not wire Pin3.

RECORD OUTPUT

The Record output wiring should be kept as short as possible. Typically less than 3m.

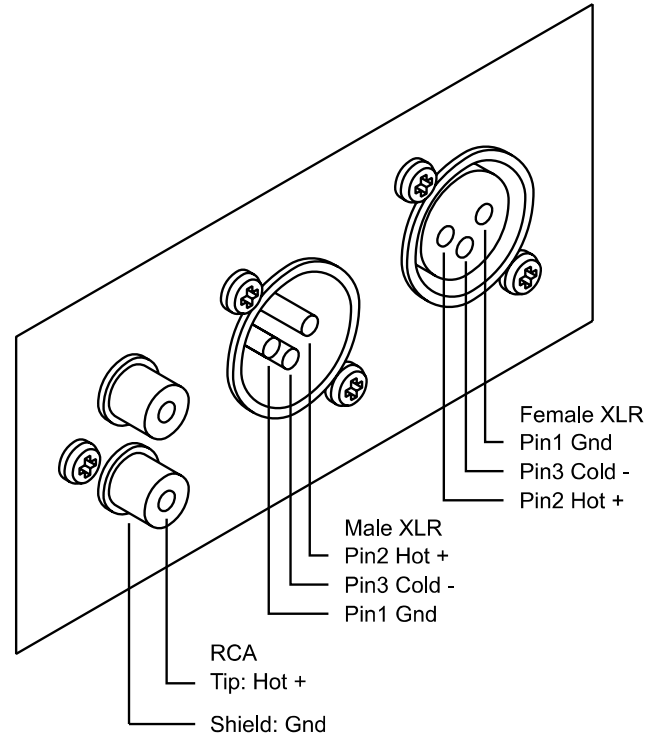

TROUBLESHOOTING GUIDE

TROUBLE	LIKELY CAUSE	REMEDY
Power LED not on	Power not reaching unit	Check mains connection Check mains fuse Check power switch is on
Noisy output	Incorrect gain structure	See setup guide
Distorted sound	Input is overloaded	Check MIC/LINE switch Reduce input level at source
	Output is being over driven	Reduce output volume
	Bass control is turned up	Reduce Bass control level
No sound but unit is on	Volume turned down	Check volume controls
Tones and/or VCA control does not work	Module not installed	Purchase optional modules
Condenser microphone does not work	Phantom power not switched on	Switch on phantom power

BASIC SETUP AND OPERATION

The inputs of the MX82 can accommodate a wide range of sources including dynamic microphones, DVD and CD players. The output may be used to drive power (booster) amplifiers, other mixers or mixer amplifiers.

Each installation will require setting the appropriate relative mix of levels between microphones and program. Also consider what the output is driving.

Setting up correct gain structure through the whole system is important to achieve optimal results. The following step by step procedure has been devised to assist during the setup process. When the MX82 was shipped to you from the factory, it was set up in a particular way. In the following procedure it is essential that you are starting from these initial settings.

- + Program Input Gain Controls – half (12 o'clock)
 - + XLR Mic/Line switch – MIC
 - + XLR Phantom power - on
 - + Input Level Controls – off
 - + Output Level Control – off
-

CONNECT THE SOURCES

First connect all the required sources to the appropriate input connectors. If the source is a microphone, set the MIC/LINE switches to the "MIC" position. If the source is an electret or condenser microphone, set the phantom switch to the "P/P on" position.

CONNECT THE OUTPUTS

Turn the amplifiers off. Connect the MX82 output to the amplifiers' line level input. Check that the MX82 is on, and then turn on the amplifiers.

If the amplifiers have a level control, set them it to a sensitivity of 0dBu. If in doubt, set it to maximum.

SET THE LEVELS

Turn the input levels up to 5. Turn up the output level until it is at an appropriate level for the listening environment. You will now have to adjust the relative levels of the inputs to achieve a good balance. The aim of these adjustments is to have all level controls at between 3 and 7. This may not be possible however. A good rule of thumb is that input level controls should be higher than the output level controls.

DIMENSIONS

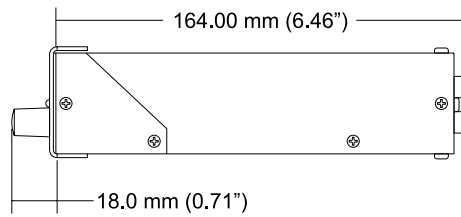
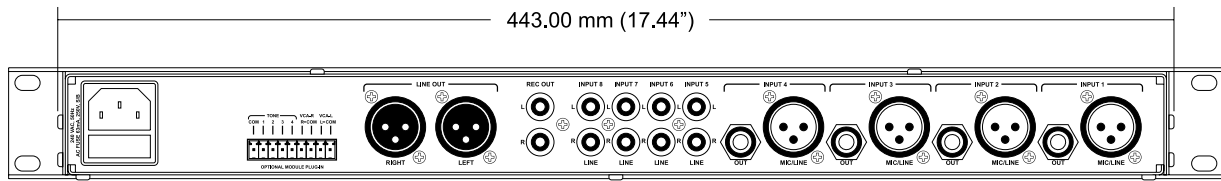
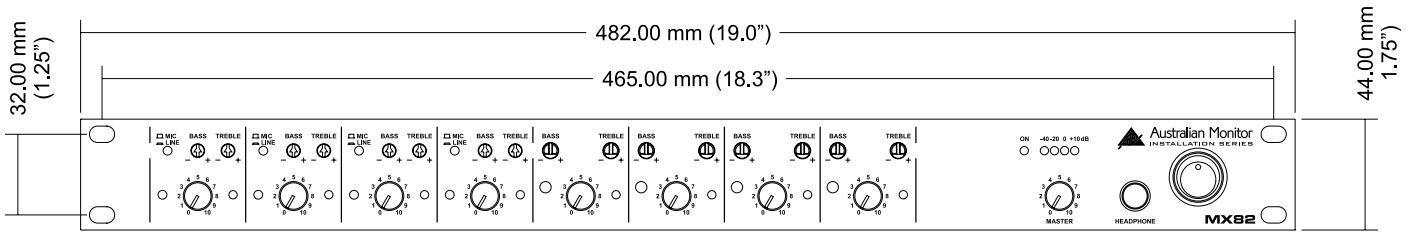

BLOCK DIAGRAM

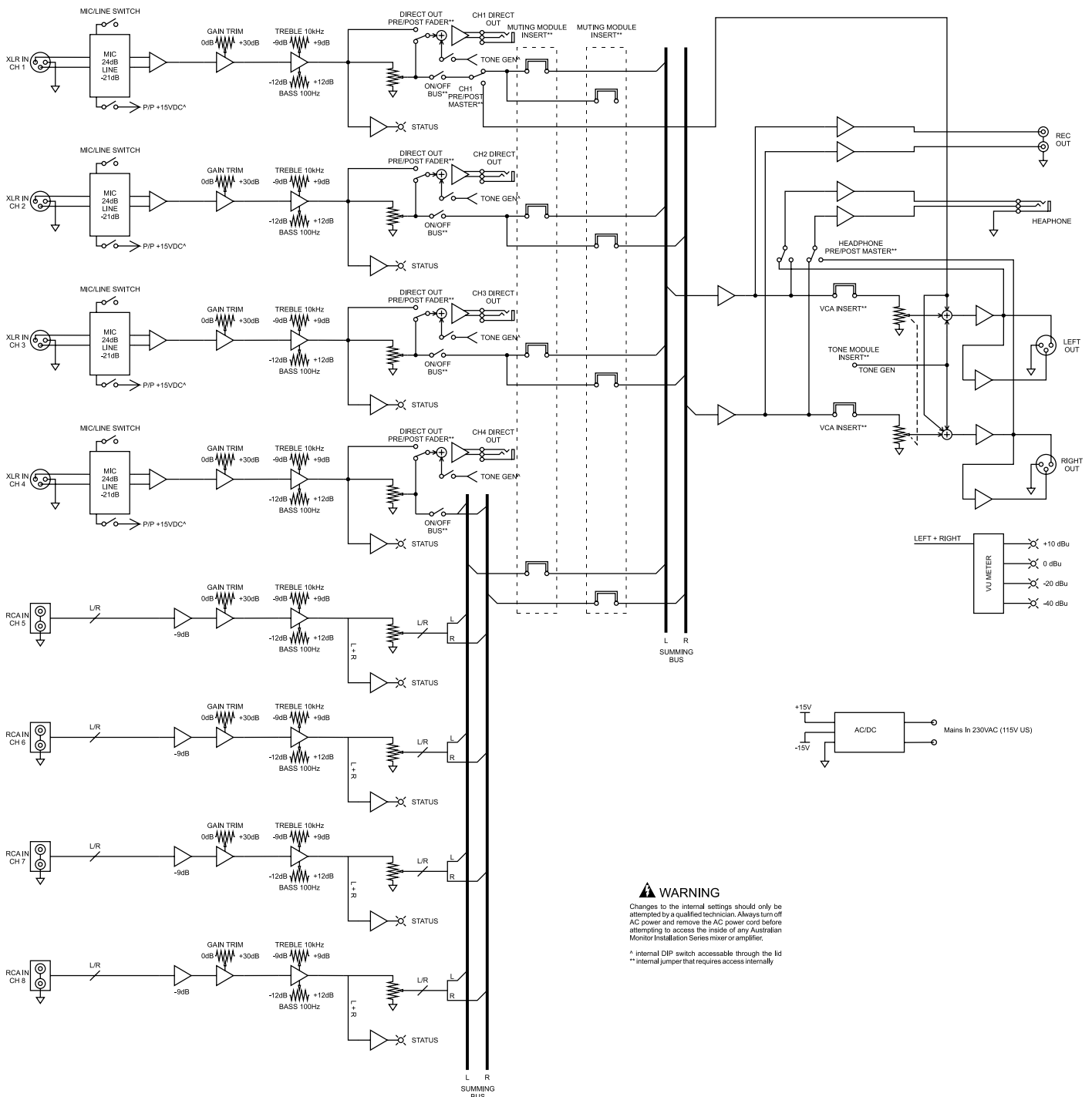

WARNING

Changes to the internal settings should only be attempted by a qualified technician. Always turn off AC power and remove the AC power cord before attempting to access the inside of any Australian Monitor Installation Series mixer or amplifier.

^a Internal DIP switch accessible through the lid
^{**} Internal jumper that requires access internally

SPECIFICATIONS

FREQUENCY RESPONSE		20Hz - 20kHz (+0,-3dB)
TOTAL HARMONIC DISTORTION		< 0.1% @ 1kHz
SIGNAL TO NOISE RATIO		> 90dB (all pots at centre position)
CROSSTALK		>70dB
TONE CONTROLS	BASS @ 100HZ TREBLE @ 10KHZ	+/- 12dB +/- 9dB
SENSITIVITY (TRIM IN CENTRE 0dB)		Mic Sens 4.36mV, -45dBu Imp 1k3ohm Line Sens 0.775V, 0dBu Imp >100k RCA 200mV, -12dBu Imp 30kohm
MAX LEVEL IN		XLR mic -9dBu line >30dBu RCA >30dBu
MAX LEVEL OUT		+27dBu
PHANTOM POWER		15V DC
OUTPUTS	MASTER OUT	Nominal Level 0dBu into 1kohm Imp 100ohm
	MONO HEADPHONE OUT	Nom -6dB into 200ohm Imp 10ohm
	STEREO REC OUT	Nom -12dB into 10kohm Imp 10kohm
	CHANNEL DIRECT OUT	Nom 0dB into 1kohm Imp 100 ohm
POWER INPUT		AC: 230V/50Hz or 115V/60Hz, 3 pin IEC320-C14 connector
POWER CONSUMPTION (MAX)		7 VA
FUSES	MAINS (115V) MAINS (230V)	120mA 63mA
DIMENSIONS H X W X D		44mm x 482mm x 182mm (1.75"x19"x7.2")
SHIPPING DIMENSIONS		90mm x 505mm x 270mm (3.5"x19.9"x10.6")
WEIGHT		Net 2.8kg (6.2lb) Shipping 3.8kg (8.4lb)

AUSTRALIA AND NEW ZEALAND

www.australianmonitor.com.au

SYDNEY

(NSW & ACT SALES)

1 Clyde Street
Silverwater
NSW 2128
Private Bag 149
Silverwater NSW 1811
Phone: (02) 9647 1411
Fax: (02) 9648 3698
Email:
nsw@audiotelex.com.au

MELBOURNE

(VIC & TAS SALES)

22/277
Middleborough Road
Box Hill VIC 3128
PO Box 151 Blackburn
South VIC 3130
Phone: (03) 9890 7477
Fax: (03) 9890 7977
Email:
vic@audiotelex.com.au

BRISBANE

(QLD SALES)

42 Commercial Road
Fortitude Valley
QLD 4006
PO Box 2578 Fortitude
Valley BC QLD 4006
Phone: (07) 3852 1312
Fax: (07) 3252 1237
Email:
qld@audiotelex.com.au

ADELAIDE

(SA & NT SALES)

31 Walsh Street
Thebarton
SA 5031
PO Box 157
Hindmarsh SA 5007
Phone: (08) 8352 4444
Fax: (08) 8352 4488
Email:
sa@audiotelex.com.au

PERTH

(WA SALES)

3/11 Howe Street
Osborne Park WA 6017
PO Box 1281
Osborne Park BC
WA 6916
Phone: (08) 9204 0200
Fax: (08) 9244 3783
Email:
wa@audiotelex.com.au

AUCKLAND

(NZ SALES)

9C Piermark Drive
Albany 0752
New Zealand
PO Box 300-512
Albany 0752
Phone: (09) 415 9426
Fax: (09) 415 9864
Email:
sales@audiotelex.co.nz

EUROPE / ASIA / MIDDLE EAST

www.australianmonitor.com.au

INTERNATIONAL SALES

1 Clyde Street Silverwater NSW 2128 Australia
Private Bag 149 Silverwater NSW 1811
Phone: + 61 2 9647 1411
Fax: + 61 2 9748 2537
Email: international@audiotelex.com.au